

Varenummer: 03550060

Beskrivelse: Fluro hydraulik ledhoved FPR 60S

Mål

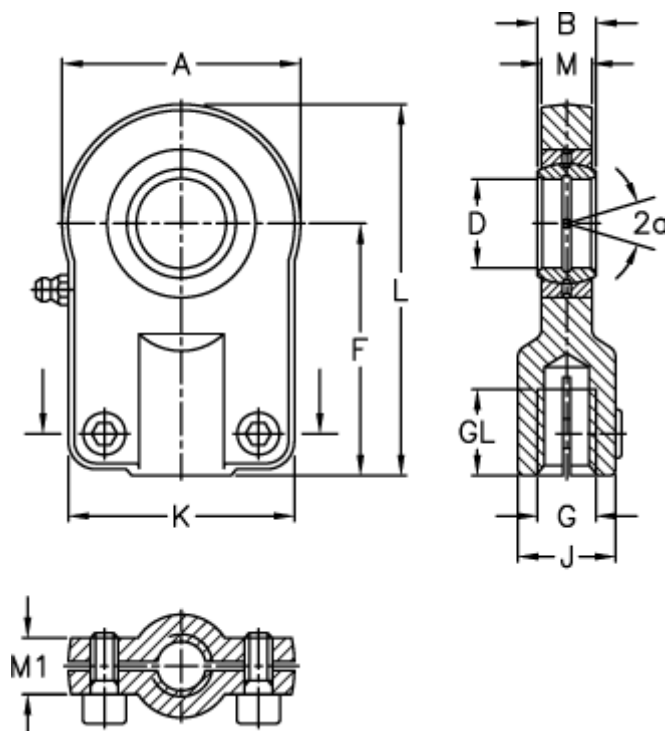

A	= 160	J	= 68
a (grader)	= 6	K	= 134
B	= 44	L	= 230
D	= 60	M	= 38
Dynamisk belastning C (kN)	= 245	M1	= 38
F	= 150	Moment (Nm)	= 210
g	= M42x2	Statisk belastning C0 (kN)	= 380
GL	= 57	Vægt	= 8400